

## **NOTICE**

This appliance is intended for professional use only and is to be operated by qualified personnel only. A Frymaster/DEAN Factory Authorized Service Center (FASC) or other qualified professional should perform installation, maintenance, and repairs. Installation, maintenance, or repairs by unqualified personnel may void the manufacturer's warranty. See Chapter 1 of this manual for definitions of qualified personnel.

## **NOTICE**

This equipment must be installed in accordance with the appropriate national and local codes of the country and/or region in which the appliance is installed. See NATIONAL CODE REQUIREMENTS in Chapter 2 of this manual for specifics.

## **NOTICE TO U.S. CUSTOMERS**

This equipment is to be installed in compliance with the basic plumbing code of the Building Officials and Code Administrators International, Inc. (BOCA) and the Food Service Sanitation Manual of the U.S. Food and Drug Administration.

## **NOTICE**

Drawings and photos used in this manual are intended to illustrate operational, cleaning and technical procedures and may not conform to onsite management operational procedures.

## **NOTICE TO OWNERS OF UNITS EQUIPPED WITH COMPUTERS**

### **U.S.**

This device complies with Part 15 of the FCC rules. Operation is subject to the following two conditions: 1) This device may not cause harmful interference, and 2) This device must accept any interference received, including interference that may cause undesired operation. While this device is a verified Class A device, it has been shown to meet the Class B limits.

### **CANADA**

This digital apparatus does not exceed the Class A or B limits for radio noise emissions as set out by the ICES-003 standard of the Canadian Department of Communications.

Cet appareil numérique n'émet pas de bruits radioélectriques dépassant les limites de classe A et B prescrites dans la norme NMB-003 édictée par le Ministre des Communications du Canada.

## **DANGER**

Improper installation, adjustment, maintenance or service, and unauthorized alterations or modifications can cause property damage, injury, or death. Read the installation, operating, and service instructions thoroughly before installing or servicing this equipment.

**⚠ DANGER**

The front ledge of this appliance is not a step! Do not stand on the appliance. Serious injury can result from slips or contact with the hot cooking oil/shortening.

**⚠ DANGER**

Do not store or use gasoline or other flammable liquids or vapors in the vicinity of this or any other appliance.

**⚠ DANGER**

The crumb tray in fryers equipped with a filter system must be emptied into a fireproof container at the end of frying operations each day. Some food particles can spontaneously combust if left soaking in certain shortening material.

**⚠ WARNING**

Do not bang fry baskets or other utensils on the fryer's joiner strip. The strip is present to seal the joint between the frypots. Banging fry baskets on the strip to dislodge shortening will distort the strip, adversely affecting its fit. It is designed for a tight fit and should only be removed for cleaning.

**NOTICE**

**IF, DURING THE WARRANTY PERIOD, THE CUSTOMER USES A PART FOR THIS ENODIS EQUIPMENT OTHER THAN AN UNMODIFIED NEW OR RECYCLED PART PURCHASED DIRECTLY FROM FRYMASTER/DEAN, OR ANY OF ITS AUTHORIZED SERVICE CENTERS, AND/OR THE PART BEING USED IS MODIFIED FROM ITS ORIGINAL CONFIGURATION, THIS WARRANTY WILL BE VOID. FURTHER, FRYMASTER/DEAN AND ITS AFFILIATES WILL NOT BE LIABLE FOR ANY CLAIMS, DAMAGES OR EXPENSES INCURRED BY THE CUSTOMER WHICH ARISE DIRECTLY OR INDIRECTLY, IN WHOLE OR IN PART, DUE TO THE INSTALLATION OF ANY MODIFIED PART AND/OR PART RECEIVED FROM AN UNAUTHORIZED SERVICE CENTER.**



**H14/H17/H22 Series Electric Fryers  
Installation and Operation Manual**

**TABLE OF CONTENTS**

|   | Page |
|---|------|
| <b>Chapter 1: Introduction</b> .....              | 1-1  |
| <b>Chapter 2: Installation Instructions</b> ..... | 2-1  |
| <b>Chapter 3: Operating Instructions</b> .....    | 3-1  |
| <b>Chapter 4: Filtration Instructions</b> .....   | 4-1  |
| <b>Chapter 5: Preventive Maintenance</b> .....    | 5-1  |
| <b>Chapter 6: Operator Troubleshooting</b> .....  | 6-1  |

## H14/H17/H22 SERIES ELECTRIC FRYERS CHAPTER 1: INTRODUCTION

---

### 1.1 General

### 1.2 Safety Information

 **DANGER**

Hot cooking oil causes severe burns. Never attempt to move a fryer containing hot cooking oil or to transfer hot cooking oil from one container to another.

 **CAUTION**  
*malfunction of your system.*

*may cause or result in a*

 **WARNING**  
*damage to your system*

*may cause or result in*

 **DANGER**  
*injury to personnel*

*may cause or result in*

Fryers in this series are equipped with these automatic safety features:

## 1.3 Computer Information

## 1.4 European Community (CE) Specific Information

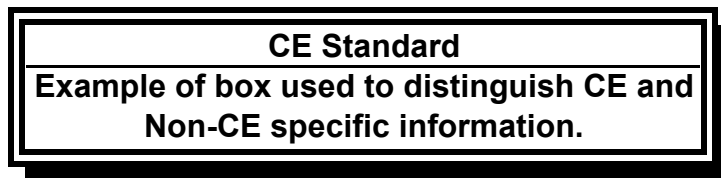

## 1.5 Shipping Damage Claim Procedure

*What to do if your equipment arrives damaged:*

## 1.6 Service Information

Model Number \_\_\_\_\_

Serial Number \_\_\_\_\_

Voltage \_\_\_\_\_

Nature of the Problem \_\_\_\_\_

\_\_\_\_\_

\_\_\_\_\_

**RETAIN AND STORE THIS MANUAL IN A SAFE PLACE FOR FUTURE USE.**

## H14/H17/H22 SERIES ELECTRIC FRYERS CHAPTER 2: INSTALLATION INSTRUCTIONS

### 2.1 General

Proper installation is essential for the safe, efficient, trouble-free operation of this appliance. Any unauthorized alteration of this equipment will void the Frymaster warranty.

#### NOTICE

If this equipment is wired directly into the electrical power supply, a means for disconnection from the supply having a contact separation of at least 3-mm in all poles must be incorporated in the fixed wiring.

#### NOTICE

This equipment must be positioned so that the plug is accessible unless other means for disconnection from the power supply (e.g., a circuit breaker) is provided.

#### NOTICE

If this appliance is permanently connected to fixed wiring, it must be connected by means of copper wires having a temperature rating of not less than 75°C (175°F).

#### NOTICE

If the electrical power supply cord is damaged, it must be replaced by a Frymaster/Dean Factory Authorized Service Center technician or a similarly qualified person in order to avoid a hazard.

#### DANGER

This appliance must be connected to a power supply having the same voltage and phase as specified on the rating plate located on the inside of the appliance door.

#### DANGER

All wiring connections for this appliance must be made in accordance with the wiring diagram(s) furnished with the appliance. Refer to the wiring diagram(s) affixed to the inside of the appliance door when installing or servicing this equipment.

#### DANGER

Frymaster appliances equipped with legs are for stationary installations. Appliances fitted with legs must be lifted during movement to avoid damage to the appliance and bodily injury. For movable installations, optional equipment casters must be used. Questions? Call 1- 800-551-1111.

**⚠ DANGER**

**Do not attach an apron drainboard to a single fryer. The fryer may become unstable, tip over, and cause injury. The appliance area must be kept free and clear of combustible material at all times.**

All installation and service on Frymaster equipment must be performed by qualified, certified, licensed, and/or authorized installation or service personnel. Service may be obtained by contacting your local Factory Authorized Service Center.

## 2.2 Power Requirements

| MODEL                | VOLTAGE | PHASE | WIRE SERVICE | MIN. SIZE | AWG (mm <sup>2</sup> ) | AMPS PER LEG |    |    |
|----------------------|---------|-------|--------------|-----------|------------------------|--------------|----|----|
|                      |         |       |              |           |                        | L1           | L2 | L3 |
| H14                  | 208     | 3     | 3            | 6         | (16)                   | 39           | 39 | 39 |
| H14                  | 240     | 3     | 3            | 6         | (16)                   | 34           | 34 | 34 |
| H14                  | 480     | 3     | 3            | 8         | (10)                   | 17           | 17 | 17 |
| H14                  | 220/380 | 3     | 4            | 6         | (16)                   | 21           | 21 | 21 |
| H14                  | 240/415 | 3     | 4            | 6         | (16)                   | 20           | 20 | 21 |
| H14                  | 230/400 | 3     | 4            | 6         | (16)                   | 21           | 21 | 21 |
| ALL                  | 208     | 3     | 3            | 6         | (16)                   | 39           | 39 | 39 |
| EPH17                | 240     | 3     | 3            | 6         | (16)                   | 34           | 34 | 34 |
| SERIES (SOLID STATE) | 220/380 | 3     | 4            | 6         | (16)                   | 21           | 21 | 21 |
|                      | 240/415 | 3     | 4            | 6         | (16)                   | 20           | 20 | 20 |
| H17                  | 208     | 3     | 3            | 6         | (16)                   | 48           | 48 | 48 |
| H17                  | 240     | 3     | 3            | 6         | (16)                   | 41           | 41 | 41 |
| H17                  | 480     | 3     | 3            | 6         | (16)                   | 21           | 21 | 21 |
| H17                  | 220/380 | 3     | 4            | 6         | (16)                   | 26           | 26 | 26 |
| H17                  | 240/415 | 3     | 4            | 6         | (16)                   | 24           | 24 | 24 |
| ALL                  |         |       |              |           |                        |              |    |    |
| EPH17                |         |       |              |           |                        |              |    |    |



 **DANGER**

**Frymaster fryers equipped with legs are for permanent installations. Fryers fitted with legs must be lifted during movement to avoid damage and possible bodily injury. For a moveable or portable installation, Frymaster optional equipment casters must be used. Questions? Call 1- 00-551-**

1. Position the fryer at the frying station.
2. Using a carpenter's level placed across the top of the frypot, level the fryer left to right and front to back.

To level fryers equipped with legs, the bottom of the legs can be screwed out up to one inch (20 mm) for leveling. The legs should be adjusted so that the fryer(s) are at the proper height in the frying station.

For fryers equipped with casters, there are no built-in leveling devices. The floor where the fryers are installed must be level.

3. For single fryers, attach restraints to prevent tipping of the fryer.
4. Plug the fryer's power cords into appropriate electrical outlets, ensuring that the face of the plug is flush against the face of the receptacle.
5. Follow the start-up procedures in Section 3.1 of this manual.

## H14/H17/H22 SERIES ELECTRIC FRYERS CHAPTER 3: OPERATING INSTRUCTIONS

### 3.1 Start-Up Procedure

#### WARNING

The on-site supervisor is responsible for ensuring that operators are made aware of the inherent hazards of operating a hot oil filtering system, particularly the aspects of oil filtration, draining and cleaning procedures.

#### DANGER

Never operate the appliance with an empty frypot. The frypot must be filled with water or cooking oil/shortening before energizing the elements. Failure to do so will result in irreparable damage to the elements and may cause a fire.

1. Ensure that the power cord(s) is/are plugged into the appropriate receptacle(s). Verify that the face of the plug is flush with the outlet plate, with no portion of the prongs visible.
2. If this is the first time the fryer is being used after installation, carry out the procedures in Section 3.2, Boiling-Out the Frypot before continuing with Step 3.
3. Fill the frypot with oil to the bottom OIL LEVEL line located on the rear of the frypot. This will allow for oil expansion as heat is applied. Do not fill cold oil any higher than the bottom line; overflow may occur as heat expands the oil.

If solid shortening is used, first raise the elements, then pack solid shortening into the bottom of the frypot. Lower the elements, and then pack solid shortening around and over the elements.

#### DANGER

Never set a complete block of solid shortening on top of the heating elements.

When using solid shortening, always pre-melt the shortening before adding it to the frypot. If the shortening is not pre-melted, it must be packed down between the elements and the fryer must be started in the melt-cycle mode.

Never cancel the melt-cycle mode when using solid shortening. Doing so will result in damage to the elements and increase the potential for a flash fire.

4. Ensure that the oil is at the *top* OIL LEVEL line when the oil *is at frying temperature*. It may be necessary to add oil or shortening to bring the level up to the proper mark, *after the oil or shortening has reached frying temperature*.
5. Place the fryer into operation.

For units equipped with *solid state (analog)* controllers, place Power Switch and the Melt Cycle switch in the ON position. Set the temperature control knob to the desired cooking temperature, referred to as the *setpoint*.

For units equipped with *other than solid state (analog)* controllers, place the computer or controller ON/OFF switch in the ON position and set the controller to – or program the computer for – the desired frying temperature, referred to as the *setpoint*.

**NOTE:** The heating elements will cycle on and off until the frypot temperature reaches 180°F (82°C). During the melt-cycle, the Heating Mode indicator will alternately illuminate and go out as the elements cycle on and off. Once the frypot temperature reaches 180°F (82°C), the fryer will automatically go into the heating mode to bring the frypot temperature to that set on the temperature control knob and will maintain it at that temperature. When the fryer is heating, the Heating Mode indicator will be illuminated.

## 3.2 Boiling-Out the Frypot

To ensure that the frypot is free of any contamination resulting from its manufacture, shipping, and handling during installation, the frypot must be boiled out before first use. Frymaster recommends boiling out the frypot each time the oil or shortening is changed.

### DANGER

**Never leave the fryer unattended during the boil-out process. If the boil-out solution boils over, turn the fryer off immediately and let the solution cool for a few minutes before resuming the process. To lessen the chance of boil over, turn the fryer's gas valve knob to the PILOT position occasionally.**



1. Before turning the fryer on, close the frypot drain valve and fill the frypot to the bottom OIL-LEVEL line with a mixture of cold water and detergent.

2. For units equipped with a *solid state (analog) controller*, set the thermostat to 195°F (91°C).

For units equipped with a *digital controller*, set the setpoint to 195°F (91°C).

For units equipped with a *Basket Lift Timer*, press the Boil-Out Mode button  to begin the boil-out process.

For units equipped with *Computer Magic III computers*,

- Press the Power switch  followed by the Program Mode switch . Code will appear in the left display.
- Enter the code number 1653. The right display will read **BOIL**. The temperature is automatically set for 195°F (91°C). The fryer will attain this temperature and remain there until the Power  switch is pressed, which cancels the boil-out mode.

3. Place the fryer into operation in accordance with Section 3.1.

4. Simmer the solution for 1 hour.

5. After the solution simmers for 1 hour, turn the fryer off, allow the solution to cool, then add 2 gallons (7.75 liters) of cold water and stir. Drain the solution into a suitable container and clean the frypot thoroughly.

 **WARNING**

**Do not drain boil-out solution into a shortening disposal unit, a built-in filtration unit, or a portable filter unit. These units are not intended for this purpose, and will be damaged by the solution.**

6. Rinse the frypot at least twice by filling the frypot with clean water and draining. Dry the frypot thoroughly with a clean, dry towel.

 **DANGER**

**Remove all drops of water from the frypot before filling with cooking oil or shortening. Failure to do so will cause spattering of hot liquid when the oil or shortening is heated to cooking temperature and may cause injury to nearby personnel.**

### 3.3 Shutting the Fryer Down

1. For fryers with solid State (analog) controllers, press the Power switch to the OFF position. The Power On light will go out.

For other types of controllers, press the ON/OFF switch  to the OFF position. The display will show OFF.

2. Filter the oil or shortening (see Chapter 4) and clean the fryer.
3. Place the frypot covers on the frypots.

### 3.4 Controller Operation and Programming

H14/H17/H22 Series electric fryers may be equipped with Computer Magic III (CM III) computers, Basket Lift Timers, Digital Controllers, or Solid State (Analog) Controllers. Refer to the separate *Frymaster Fryer Controllers User's Manual* provided with your equipment for instructions on using the particular controller supplied with your fryer.

## H14/H17/H22 SERIES ELECTRIC FRYERS CHAPTER 4: FILTRATION INSTRUCTIONS

### 4.1 Draining and Manual Filtering: Non-Filtration Fryers

 **DANGER**

**Allow oil/shortening to cool to 100°F (38°C) or lower before draining to an appropriate container for disposal.**

If your fryer is not equipped with a built-in filtration system (FootPrint III or Filter Magic II), the cooking oil or shortening must be drained into another suitable container. (For safe, convenient draining and disposal of used cooking oil or shortening, Frymaster recommends using the Frymaster *Shortening Disposal Unit* (SDU). The SDU is available through your local distributor.)

1. Turn the controller power switch to the OFF position. Screw the drainpipe (provided with your fryer) into the drain valve. Make sure the drainpipe is firmly screwed into the drain valve and that the opening is pointing down.
2. Position a metal stockpot with a sealable cover under the drainpipe. If you intend to reuse the oil or shortening, Frymaster recommends that a Frymaster filter cone holder and filter cone be used when a filter machine is not available. If you are using a Frymaster filter cone holder, be sure that the cone holder rests securely on the metal container.
3. Open the drain valve slowly to avoid splattering. If the drain valve becomes clogged with food particles, use the Fryer's Friend (poker-like tool) to clear the blockage.

 **DANGER**

**DO NOT insert anything into the drain from the front to unclog the valve. Hot oil/shortening will rush out, creating an extreme hazard.**

 **WARNING**

**DO NOT hammer on the drain valve with the Fryer's Friend. This will damage the drain valve ball and prevent the valve from sealing securely, resulting in a leaky valve.**

4. After draining the oil/shortening, clean all food particles and residual oil/shortening from the frypot. **BE CAREFUL**, this material may still cause severe burns if it contacts bare skin.
5. Close the drain valve securely and fill the frypot with clean, filtered or fresh cooking oil or shortening to the bottom OIL-LEVEL line.

 **DANGER**

**NEVER set a complete block of solid shortening on top of the heating elements.**

**When using solid shortening, always pre-melt the shortening before adding it to the frypot. If the shortening is not pre-melted, it must be packed down between the elements and the fryer must be started in the melt-cycle mode. NEVER cancel the melt-cycle mode when using solid shortening. Doing so will result in damage to the elements and increase the potential for a flash fire.**

## 4.2 Built-In Filtration System Operation

Both the FootPrint III (FP III) and Filter Magic II (FM II) filtration systems allow the cooking oil or shortening in one frypot to be safely and efficiently filtered while the other frypots in a battery remain in operation. Although different in design and appearance, the operation of the FootPrint III and Filter Magic II systems is identical. Operation of the FootPrint III system is illustrated in this discussion, but the steps described apply equally to the Filter Magic II system.

Most reported problems with these systems are caused by improper operation. Careful attention to the step-by-step instructions that follow will ensure that your system operates as intended.

### 4.2.1 Preparing the Filter Unit for Use

1. Pull the filter unit from the cabinet, open the cover, remove the crumb tray, and remove the paper hold-down ring.



Handles

*Slide Pan Assembly Out*

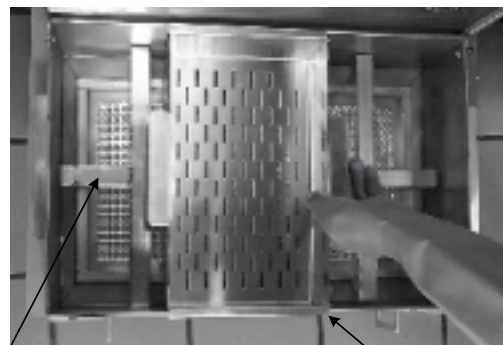

Paper Hold-down Ring

Crumb Tray

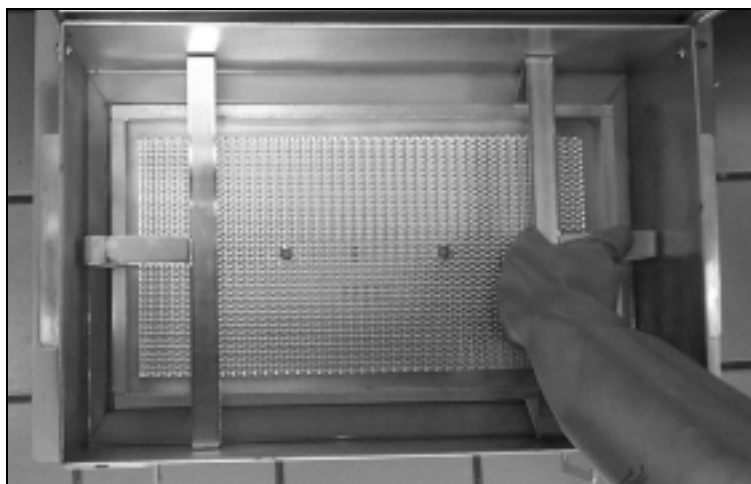

Remove the Hold-down Ring

**NOTE:** If changing filter paper, remove the crumb tray and paper hold-down ring and clean with a solution of hot water and dishwashing detergent. Remove and discard the used filter paper. **Be careful, the oil-soaked paper may be very hot and may cause burns.** Remove the metal filter screen and pan and clean thoroughly using a solution of hot water and detergent, ensuring that all breadings and food particles are removed from the pan, ensuring the pan is dried completely. Allow the screen to dry completely before reinstalling.



2. After verifying that the metal filter screen is in the bottom of the pan, lay a sheet of filter paper over the top of the pan, overlapping on all sides.

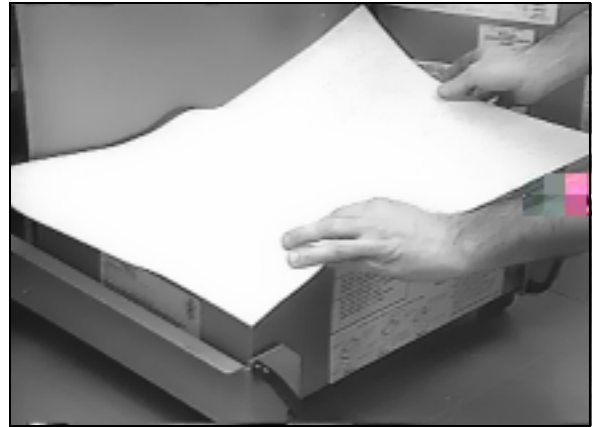

3. Position the hold-down ring over the filter paper and lower the ring into the pan, allowing the paper to fold up around the ring as it is pushed to the bottom of the pan.
4. Sprinkle filter powder over the filter paper. (For powder quantity, see the filter powder manufacturer's instructions.) Replace the crumb tray in the filter pan and close the cover.



5. Push the filter pan back into the fryer, positioning it all the way to the back of the cabinet. (Some older filter systems have a green HEATER ON indicator, which will light when the assembly is properly positioned.)



## 4.2.2 OPERATION OF THE FILTER UNIT

### CAUTION

**Never operate the filter unit unless cooking oil is at operating temperature.**

1. To filter the cooking oil, turn the fryer power OFF, then open the drain valve on the fryer you have selected to filter. If necessary, use the *Fryer's Friend* cleanout rod to clear the drain from **inside** the frypot.



### DANGER

**DO NOT** insert anything into the drain from the front to unclog the valve. Hot oil/shortening will rush out, creating an extreme hazard.

### WARNING

**DO NOT** hammer on the drain valve with the Fryer's Friend. This will damage the drain valve ball and prevent the valve from sealing securely, resulting in a leaky valve.



2. Install the Power Shower (if the fryer is so equipped).



Remove the basket support rack from the frypot, raise the element assembly to the up position, and snap the Power Shower into position.

**⚠ DANGER**

**DO NOT operate the filter without the Power Shower in place unless unit is configured with a rear flush option. Hot oil will spray out of the fryer and may cause injury.**

4. After all oil has drained from the pot, turn the filter handle to ON to start the pump and begin the filtering process. (For units equipped with a rear-flush option, position the control lever to either the Power Shower or Rear Flush position.) There may be a slight delay before the pump activates.



5. The filter pump draws the cooking oil/shortening through the filter and circulates it back up to and through the fryer during a 5-minute process called polishing. Polishing cleans the oil by trapping solid particles in the filter medium.
6. After the oil is filtered (about 5 minutes), close the drain valve and allow the fryer to refill. Let the filter pump run 10 to 12 seconds after bubbles appear in the oil (or it begins to sputter from the Power Shower on fryers so equipped). Turn the filter off (and remove the Power Shower and let it drain, if so equipped).

## WARNING

The filter pump is equipped with a manual reset switch in case the filter motor overheats or an electrical fault occurs. If this switch trips, turn off power to the filter system and allow the pump motor to cool 20 minutes before attempting to reset the switch.

In FootPrint III units, pull the filter base assembly out to access the pump motor. In Filter Magic II units, the reset switch can be reached through the door of the FM II cabinet without pulling out the filter pan assembly. In both cases, the reset switch is the red button located on the face of the motor.

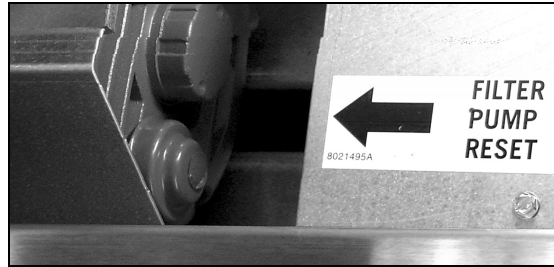

7. Lower the elements into the frypot and reinstall the basket support rack.
8. Ensure the drain valve is fully closed. (If the drain valve is not fully closed, the controller will display an error message or a trouble light and the fryer will not operate.) Turn the fryer ON and allow the cooking oil/shortening to reach setpoint.

## DANGER

The crumb tray in fryers equipped with a filter system must be emptied into a fireproof container at the end of frying operations each day. Some food particles can spontaneously combust if left soaking in certain shortening material.

## WARNING

Do not bang fry baskets or other utensils on the fryer's joiner strip. The strip is present to seal the joint between the fry vessels. Banging fry baskets on the strip to dislodge shortening will distort the strip, adversely affecting its fit. It is designed for a tight fit and should only be removed for cleaning.

## H14/H17/H22 SERIES ELECTRIC FRYERS CHAPTER 5: PREVENTATIVE MAINTENANCE

### 5.1 Cleaning the Fryer

 **DANGER**

The crumb tray in fryers equipped with a filter system must be emptied into a fireproof container at the end of frying operations each day. Some food particles can spontaneously combust if left soaking in certain shortening material.

 **DANGER**

Never attempt to clean the fryer during the frying process or when the frypot is filled with hot oil/shortening. If water comes in contact with oil/shortening heated to frying temperature, it will cause spattering of the oil/shortening, which can result in severe burns to nearby personnel.

 **WARNING**

Use a commercial-grade cleaner formulated to effectively clean and sanitize food-contact surfaces. Read the directions for use and precautionary statements before use. Particular attention must be paid to the concentration of cleaner and the length of time the cleaner remains on the food-contact surfaces.

#### 5.1.1 Clean Inside and Outside of Fryer Cabinet – Daily

Clean inside the fryer cabinet with a dry, clean cloth. Wipe all accessible metal surfaces and components to remove accumulated oil/shortening and dust.

Clean outside the fryer cabinet, with a clean, damp cloth soaked with dishwashing detergent. Wipe with a clean, damp cloth.

#### 5.1.2 Clean the Built-in Filtration System – Daily

 **WARNING**

**Never drain water into the filter pan. Water will damage the filter pump.**

Clean the FootPrint III or Filter Magic II filter pan daily with a solution of hot water and dishwashing detergent.

Immediately after each use, drain the Power Shower completely. If oil is leaking at the point where the Power Shower plugs into the frypot, verify the O-ring and gasket on the connection fitting are present, and in good condition. If you suspect blockage, unscrew the clean-out plugs at each corner of the frame. Place the frame in a pan of hot water for several minutes to melt any solidified oil/shortening. Use a long, narrow bottlebrush, hot water and detergent to clean inside the flare. If necessary, insert a straightened paper clip or similarly sized wire into the holes in the frame to remove any solidified shortening or other blockages. Rinse with hot water, dry thoroughly, and reinstall the plugs before using.

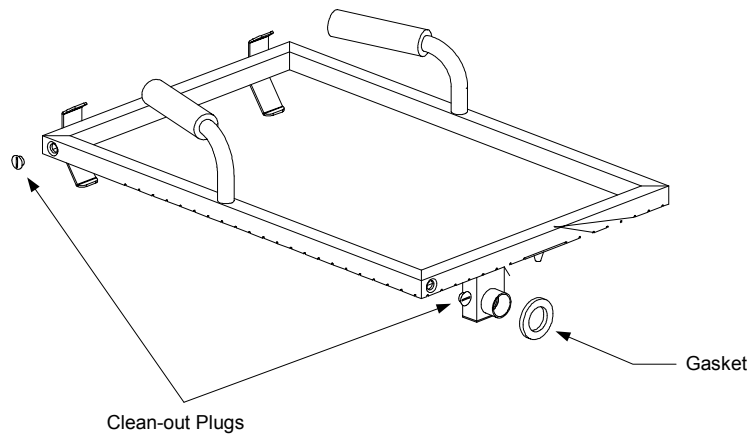

## **⚠ DANGER**

Failure to reinstall the clean-out plugs in the Power Shower will cause hot oil/shortening to spray out of the frypot during the filtering process, creating an extreme burn hazard to personnel.

### 5.1.3 Clean the Frypot and Heating Elements – Weekly

## **⚠ WARNING**

Never operate the appliance with an empty frypot. The frypot must be filled with water or cooking oil/shortening before energizing the elements. Failure to do so will result in irreparable damage to the elements and may cause a fire.

### Boiling Out the Frypot:

Before the fryer is first used, it should be boiled out to ensure that residue from the manufacturing process has been eliminated. Also, after the fryer has been in use for a period of time, a hard film of caramelized vegetable oil will form on the inside of the frypot. This film should be periodically removed by following the boil-out procedure that follows:

1. Before switching the fryer(s) ON, close the frypot drain valve(s) and fill the empty frypot with a mixture of cold water and dishwashing detergent. Follow detergent manufacturer's instructions for mixing.
2. Press the fryer ON/OFF switch to the ON position. On fryers equipped with solid state (analog) controllers, set the melt switch to OFF.
3. For fryers equipped with Computer Magic III computers, program the computer for boil-out as described in the separate *Frymaster Fryer Controllers User's Manual*.

For fryers with digital controllers, set the temperature to 195°F (91°C) as described in the separate *Frymaster Fryer Controllers User's Manual*.

For fryers with solid state (analog) controllers, set the temperature control knob to 195° (91°C).

4. Simmer the solution for 45 minutes to one hour. Do not allow the water level to drop below the bottom oil-level line in the frypot during boil-out operation.

**⚠ WARNING**

**DO NOT leave the fryer unattended during the boil-out process. If the solution foams excessively and overflows, press the ON/OFF switch to the OFF position immediately. Allow solution to settle, then continue with the boil-out process.**

5. Place the fryer ON/OFF switch(s) in the OFF position.
6. Add two gallons of water. Drain out the solution and clean the frypot(s) thoroughly.

**⚠ CAUTION**

**Do not drain boil-out solution into a shortening disposal unit, a built-in filtration unit, or a portable filter unit. These units are not intended for this purpose, and will be damaged by the solution.**

7. Refill the frypot(s) with clean water. Rinse the frypot(s) twice, drain and dry with a clean towel. Thoroughly remove all water from the frypot and elements before filling the frypot with cooking oil/shortening.

**⚠ DANGER**

**Remove all drops of water from the frypot before filling with cooking oil or shortening. Failure to do so will cause spattering of hot liquid when the oil or shortening is heated to cooking temperature.**

#### **5.1.4 Clean Detachable Parts and Accessories – Weekly**

Wipe all detachable parts and accessories with a clean, dry cloth. Use a clean cloth saturated with dishwashing detergent to remove accumulated carbonized oil/shortening on detachable parts and accessories. Rinse the parts and accessories thoroughly with clean water and wipe dry before reinstalling.

## 5.3 Annual/Periodic System Inspection

**This appliance should be inspected and adjusted periodically by qualified service personnel as part of a regular kitchen maintenance program.**

**Frymaster recommends that this appliance be inspected at least annually by a Factory Authorized Service Technician as follows:**

### **Fryer**

- Inspect the cabinet inside and out, front and rear for excessive oil build-up and/or oil migration.
- Verify that the heating element wires are in good condition and that leads have no visible fraying or insulation damage and that they are free of oil migration build-up.
- Verify that heating elements are in good condition with no carbon/caramelized oil build-up. Inspect the elements for signs of extensive dry-firing.
- Verify that the tilt mechanism is working properly when lifting and lowering elements, and that the element wires are not binding and/or chafing.
- Verify the heating-element amp-draw is within the allowed range as indicated on the appliance's rating plate.
- Verify that the temperature and high-limit probes are properly connected, tightened and functioning properly, and that mounting hardware and probe guards are present and properly installed.
- Verify that component box and contactor box components (i.e. computer/controller, relays, interface boards, transformers, contactors, etc.) are in good condition and free from oil migration build-up and other debris.
- Verify that component box and contactor box wiring connections are tight and that wiring is in good condition.
- Verify that all safety features (i.e. contactor shields, drain safety switches, reset switches, etc.) are present and functioning properly.
- Verify that the frypot is in good condition and free of leaks and that the frypot insulation is in serviceable condition.
- Verify that all wiring harnesses and connections are tight and in good condition.

### **Built-In Filtration System**

- Inspect all oil-return and drain lines for leaks and verify that all connections are tight.
- Inspect the filter pan for leaks and cleanliness. If there is a large accumulation of crumbs in the crumb basket, advise the owner/operator that the crumb basket should be emptied into a fireproof container and cleaned daily.

- Verify that all O-rings and seals (including those on the Power Shower and on quick-disconnect fittings) are present and in good condition. Replace o-rings and seals if worn or damaged.
- Check filtration system integrity as follows:
  - With the filter pan empty, place each oil return handle, one at a time, in the ON position. Verify that the pump activates and that bubbles appear in the cooking oil/shortening (or that gurgling is heard from the Power Shower port) of the associated frypot..
  - Close all oil return valves (i.e., place all oil return handles in the OFF position). Verify proper functioning of each oil return valve by activating the filter pump using the lever on one of the oil return handle microswitches. No air bubbles should be visible in any frypot (or no gurgling should be heard from the Power Shower ports).
  - Verify that the filter pan is properly prepared for filtering, then drain a frypot of oil heated to 350°F (177°C) into the filter pan and close the frypot drain valve. Place the oil return handle in the ON position. Allow all cooking oil/shortening to return to the frypot (indicated by bubbles in the cooking oil/shortening or, on units with Power Showers, cessation of oil flow from the Power Shower). Return the oil return handle to the OFF position. The frypot should have refilled in no more than 2 minutes and 30 seconds.

# H14/H17/H22 SERIES ELECTRIC FRYERS

## CHAPTER 6: OPERATOR TROUBLESHOOTING

---

### 6.1 Introduction

This section provides an easy reference guide to some of the common problems that may occur during the operation of this equipment. The troubleshooting guides that follow are intended to help correct, or at least accurately diagnose, problems with this equipment. Although the chapter covers the most common problems reported, you may encounter problems that are not covered. In such instances, the Frymaster Technical Services staff will make every effort to help you identify and resolve the problem.

When troubleshooting a problem, always use a process of elimination starting with the simplest solution and working through to the most complex. Never overlook the obvious – anyone can forget to plug in a cord or fail to close a valve completely. Most importantly, always try to establish a clear idea of why a problem has occurred. Part of any corrective action involves taking steps to ensure that it doesn't happen again. If a controller malfunctions because of a poor connection, check all



## 6.2 Troubleshooting

### 6.2.1 Control and Heating Problems

| Problem                                  | Probable Causes   | Corrective Action  |
|--|---|--|
| <p><b>Controller won't activate.</b></p> | <p>A. Power cord is not plugged in or circuit breaker is tripped.</p> | <p>A. Plug power cord in and verify that circuit breaker is not tripped.</p>   |
|  | <p>B. Controller has failed.</p>                                      | <p>B. If available, substitute a controller known to be working for the suspect controller. If the substitute controller functions correctly, order a new controller from FASC.</p>  |
|  | <p>C. Power supply component or interface board has failed.</p>       | <p>C. If any of the components in the power supply system (including the transformer and interface board) fail, power will not be supplied to the controller and it will not function. Determining which component has failed is beyond the scope of operator troubleshooting. Call FASC.</p>  |
| <p><b>Fryer does not heat.</b></p>       | <p>A. Drain valve is open.</p>  | <p>A. This fryer is equipped with a drain safety switch that prevents the heating element from being energized if the drain valve is not fully closed. Verify that the drain valve is fully closed.</p>  |
|  | <p>B. Controller has failed.</p>                                      | <p>B. If available, substitute a controller known to be working for the suspect controller. If the substitute controller functions correctly, order a new controller from FASC.</p>  |
|  | <p>C. One or more other components have failed.</p>                   | <p>C. If the circuitry in the fryer control system cannot determine the frypot temperature, the system will not allow the element to be energized or will de-energize the element if it is already energized. If the contactor, element, or associated wiring fails, the element will not energize. Determining which specific component is malfunctioning is beyond the scope of operator troubleshooting. Call FASC.</p> |

| Problem  | Probable Causes                                    | Corrective Action   |
|--|--|---|
| <p><b>Fryer repeatedly cycles on and off when first started.</b></p>     | <p>Fryer is in melt-cycle mode.</p>                | <p>This is normal for fryers equipped with <i>CM III computers, Basket Lift Timers, and Digital Controllers</i>. The default operational mode for these controllers is for the elements to cycle on and off until the temperature in the frypot reaches 180°F (82°C). In CM III computers, <b>CYCL</b> will appear in the display when in the melt-cycle mode. The purpose of the melt-cycle is to allow controlled melting of solid shortening to prevent scorching and flash fires or damage to the element. If you are not using solid shortening, the melt-cycle can be cancelled or bypassed. Refer to the separate <i>Frymaster Fryer Controllers User's Manual</i> for the procedure for canceling the melt-cycle for the particular controller installed on your fryer.</p> <p>In fryers equipped with <i>Solid State (Analog)</i> controllers, the melt-cycle is controlled manually by means of the rocker switch to the right of the temperature control knob. <i>If not using solid shortening</i>, press the rocker switch to the OFF position to turn off the melt-cycle.</p> |
| <p><b>Fryer does not heat after filtering.</b></p>                       | <p>Drain valve is open.</p>                        | <p>This fryer is equipped with a drain safety switch that prevents the heating element from being energized if the drain valve is not fully closed. Verify that the drain valve is fully closed.</p>  |
| <p><b>Fryer heats until high-limit trips with heat indicator ON.</b></p> | <p>Temperature probe or controller has failed.</p> | <p>If available, substitute a controller known to be working for the suspect controller. If the substitute controller functions correctly, order a new controller from FASC. If substitution of the controller does not resolve the problem, the most likely cause is a failed temperature probe. Call FASC.</p>  |

| Problem  | Probable Causes                                    | Corrective Action   |
|--|--|---|
| <b>Fryer heats until high-limit trips without heat indicator ON.</b> | Contactor or controller has failed.                | If available, substitute a controller known to be working for the suspect controller. If the substitute controller functions correctly, order a new controller from FASC. If substitution of the controller does not resolve the problem, the most likely cause is a contactor failed in the closed position. Call FASC.  |
| <b>Fryer stops heating with heat indicator ON.</b>                   | The high-limit thermostat or contactor has failed. | The fact that the heat indicator is ON indicates that the controller is functioning properly and is calling for heat. The high-limit thermostat functions as a normally closed switch. If the thermostat fails, the "switch" opens and power to the elements is shut off. If the contactor fails to close, no power is supplied to the elements. Determining which component has failed is beyond the scope of operator troubleshooting. Call FASC. |

## 6.2.2 Error Messages and Display Problems

| Problem   | Probable Causes   | Corrective Action  |
|---|---|--|
| <b>Basket lift timer display shows <i>HELP</i>.</b> | Open drain valve or problem with latching circuits                                | Verify that the drain valve is fully closed. The fryer will not function if the drain valve is not fully closed. If the drain valve is fully closed, the problem is within the latching circuitry and is beyond the scope of operator trouble shooting. Call FASC. |
| <b>Basket lift timer display shows <i>HOT</i>.</b>  | Frypot temperature is more than 410°F (210°C) or, in CE countries, 395°F (202°C). | This is an indication of a malfunction in the temperature control circuitry, including a failure of the high-limit thermostat. Shut the fryer down immediately and call FASC.  |

| Problem   | Probable Causes  | Corrective Action  |
|---|--|--|
| <p style="text-align: center;"><b>Basket lift timer display shows</b><br/><i>Pr ob.</i></p>                     | <p>Problem with the temperature measuring circuitry including the probe.</p>             | <p>This indicates a problem within the temperature measuring circuitry that is beyond the scope of operator troubleshooting. Shut the fryer down and call FASC.</p>  |
| <p style="text-align: center;"><b>CM III display is in wrong temperature scale (Fahrenheit or Celsius).</b></p> | <p>Incorrect display option programmed.</p>  | <p>CM III computers may be programmed to display in either Fahrenheit or Celsius. Refer to the separate <i>Frymaster Fryer Controllers User's Manual</i> for instructions on changing the display.</p>   |
| <p style="text-align: center;"><b>CM III or Digital Controller display shows</b><br/><i>HELP.</i></p>           | <p>Open drain valve or problem with latching circuitry.</p>                              | <p>Verify that the drain valve is fully closed. The fryer will not function if the drain valve is not fully closed. If the drain valve is fully closed, the problem is within the latching circuitry and is beyond the scope of operator trouble shooting. Call FASC.</p>  |
| <p style="text-align: center;"><b>display shows</b> <i>HI.</i></p>  | <p>Fryer is more than 21°F (12°C) above setpoint.</p>                                    | <p>This display is normal if the fryer setpoint has been changed to a lower temperature. The display should revert to the normal four dashes when the frypot temperature cools to the setpoint. If the setpoint has not been changed, this indicates a problem with the temperature control circuitry. Turn the fryer off and call FASC.</p> |
| <p style="text-align: center;"><b>CM III or Digital Controller display shows</b> <i>HOT.</i></p>                | <p>Frypot temperature is more than 410°F (210°C) or, in CE countries, 395°F (202°C).</p> | <p>This is an indication of a malfunction in the temperature control circuitry, including a failure of the high-limit thermostat. Shut the fryer down immediately and call FASC.</p>   |

| Problem   | Probable Causes  | Corrective Action  |
|---|--|--|
| <p style="text-align: center;"><b>CM III<br/>or<br/>Digital Controller<br/>display shows <i>Lo</i>.</b></p>       | <p>Frypot temperature is more than 21°F (12°C) below setpoint.</p>                                   | <p>This display is normal when the fryer is first turned on and may appear for a short while if a large batch of frozen product is added to the frypot. If the display never goes out, the fryer is not heating. Look for a decimal in the LED display between digits 1 and 2. If the decimal is present, the computer is calling for heat and is functioning properly. See <i>Fryer Does Not Heat</i> in Control and Heating Problems (Section 6.2.1). If the decimal is not present, the computer is not calling for heat and may be malfunctioning. If available, substitute a controller known to be working for the suspect computer. If the fryer functions correctly with the substitute computer, order a replacement computer from your FASC.</p> |
| <p style="text-align: center;"><b>CM III<br/>or<br/>Digital Controller<br/>display shows<br/><i>Prob.</i></b></p> | <p>Problem with the temperature measuring circuitry including the probe.</p>                         | <p>This indicates a problem within the temperature measuring circuitry that is beyond the scope of operator troubleshooting. Shut the fryer down and call FASC.</p>  |
| <p style="text-align: center;"><b>CM III frypot<br/>temperature is<br/>displayed constantly.</b></p>              | <p>Computer is programmed for constant temperature display.</p>                                      | <p>The CM III computer may be programmed for constant temperature display or countdown timer display. Refer to the separate <i>Frymaster Fryer Controllers User's Manual</i> for instructions on toggling between these display options.</p>   |
| <p style="text-align: center;"><b>Solid state controller<br/>trouble light ON.</b></p>                            | <p>Oil temperature above acceptable range or a problem with the temperature measuring circuitry.</p> | <p>This is an indication of a malfunction in the temperature measuring or control circuitry, including a failure of the high-limit thermostat. Determining the specific problem is beyond the scope of operator troubleshooting. Shut the fryer down immediately and call FASC.</p>  |

| Problem   | Probable Causes                                    | Corrective Action   |
|---|--|---|
| <b>Solid state controller trouble light ON and heating mode light ON.</b> | Open drain valve or problem with latching circuits | Verify that the drain valve is fully closed. The fryer will not function if the drain valve is not fully closed. If the drain valve is fully closed, the problem is within the latching circuitry and is beyond the scope of operator troubleshooting. Call FASC. |

### 6.2.3 Basket Lift Problems

| Problem  | Probable Causes                          | Corrective Action   |
|--|--|---|
| <b>Basket lift movement is noisy, jerky, or erratic.</b> | Lack of lubrication on basket lift rods. | Apply a light coating of Lubriplate™ or similar lightweight white grease to the rod and bushings. |

### 6.2.4 Filtration Problems

| Problem   | Probable Causes   | Corrective Action  |
|---|---|--|
| <b>Filter pump won't start.</b>   | A. Power cord is not plugged in or circuit breaker is tripped.  | A. Verify that the power cord is fully plugged in. If so, verify that circuit breaker is not tripped.  |
|   | B. Pump motor has overheated causing the thermal overload switch to trip.   | B. If the motor is too hot to touch for more than a few seconds, the thermal overload switch has probably tripped. Allow the motor to cool at least 45 minutes then press the Pump Reset Switch.                   |
|   | C. Blockage in filter pump.<br><br><b>Test:</b> Close the drain valve and pull the filter pan out from the fryer. Activate the pump. If the pump motor hums for a short time then stops, the probable cause is blockage of the pump itself.                 | C. Pump blockages are usually caused by sediment buildup in the pump due to improperly sized or installed filter paper and failure to use the crumb screen. Call FASC.   |
| <b>Filter pump runs but oil does not return to frypot and there is no bubbling oil or air coming from the Power Shower.</b> | Blockage in filter pan suction tube.<br><br><b>Test:</b> Close the drain valve and pull the filter pan out from the fryer. Activate the pump. If the air or bubbling oil comes out of the Power Shower, there is a blockage in the filter pan suction tube. | The blockage may be caused by sediment buildup or, if solid shortening is used, solidified shortening in the tube. Use a thin, flexible wire to remove the blockage. If the blockage cannot be removed, call FASC. |

| Problem  | Probable Causes  | Corrective Action  |
|--|--|--|
| <b>Filter pump runs, but oil return is very slow and bubbling oil comes out of the Power Shower.</b> | A. Improperly installed filter pan components.                         | A. If using filter paper or pad configuration, verify that filter screen is in bottom of pan with paper or pad on top of screen.<br><br>Verify that o-rings are present and in good condition on filter pan connection fitting.  |
|  | B. Attempting to filter with oil or shortening that is not hot enough. | B. In order to properly filter, the oil or shortening should be at or near 350°F (177°C). At temperatures lower than this, the oil/shortening becomes too thick to pass through the filter medium easily, resulting in much slower oil return and eventual overheating of the filter pump motor. Make sure oil/shortening is at or near frying temperature before draining oil into filter pan.  |
| <b>Power Shower not spraying properly.</b>   | A. Missing or worn Power Shower gasket.                                | A. Verify that the gasket is present and in good condition.  |
|  | B. Clogged openings in Power Shower frame.                             | B. If the Power Shower is not cleaned on a routine basis, sediment will eventually block the small holes around the edges of the frame. Also, when using solid shortening, if the Power Shower is not allowed to drain completely, the shortening will solidify in the holes and may fill the frame. Completely drain the Power Shower after each filtering and clean regularly in accordance with the instructions in Chapter 5 of this manual. |

### 6.3 Replacing the Controller or Controller Wiring Harness

1. Disconnect the fryer from the electrical supply, remove the two screws in the upper corners of the control panel and swing the panel open from the top, allowing it to rest on its hinge tabs.
2. Disconnect the wiring harness from the back of the controller. ***If replacing the harness,*** disconnect it from the interface board. ***If replacing the controller,*** disconnect the ground wire and remove the controller by lifting it from the hinge slots in the control panel frame.
3. Reverse the procedure to install a new controller or wiring harness.



Frymaster, L.L.C., 8700 Line Avenue, PO Box 51000, Shreveport, Louisiana 71135-1000

Shipping Address: 8700 Line Avenue, Shreveport, Louisiana 71106

TEL 1-318-865-1711

FAX (Parts) 1-318-219-7140

(Tech Support) 1-318-219-7135

SERVICE HOTLINE

819-5473

PRINTED IN THE UNITED STATES

1-800-554-8622

AUGUST 2002

[WWW.INTERNATIONALKESSEL.COM](http://WWW.INTERNATIONALKESSEL.COM)



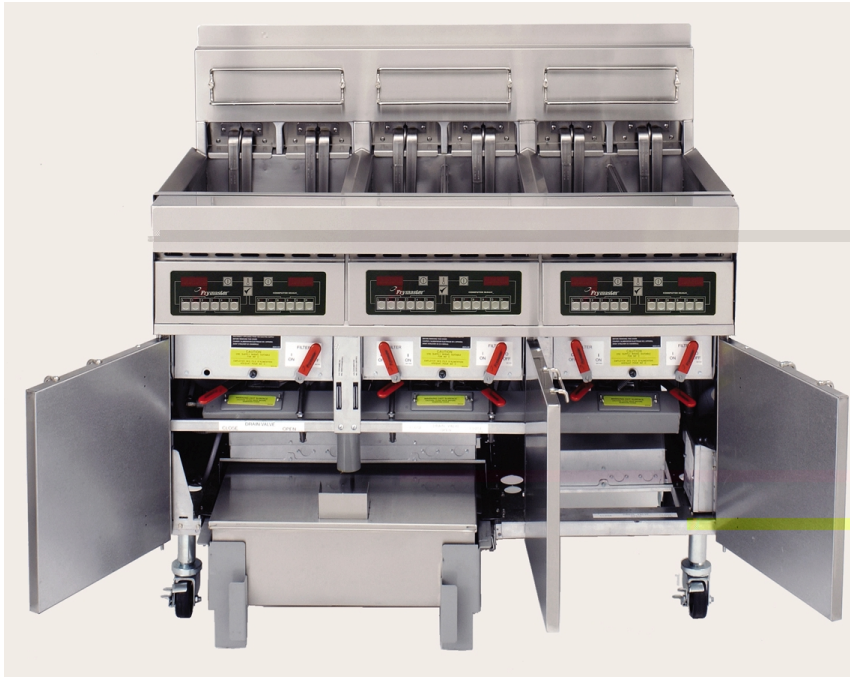

**H14/H17/H22 SERIES  
ELECTRIC FRYERS**  
(Beginning with Series Code AN)  
**Installation & Operation Manual**



Frymaster, a member of the Commercial Food Equipment Service Association, recommends using CFESA Certified Technicians.

**24-Hour Service Hotline 1-800-551-8633**

**Price: \$8.00  
819-5473  
AUGUST 2002**